

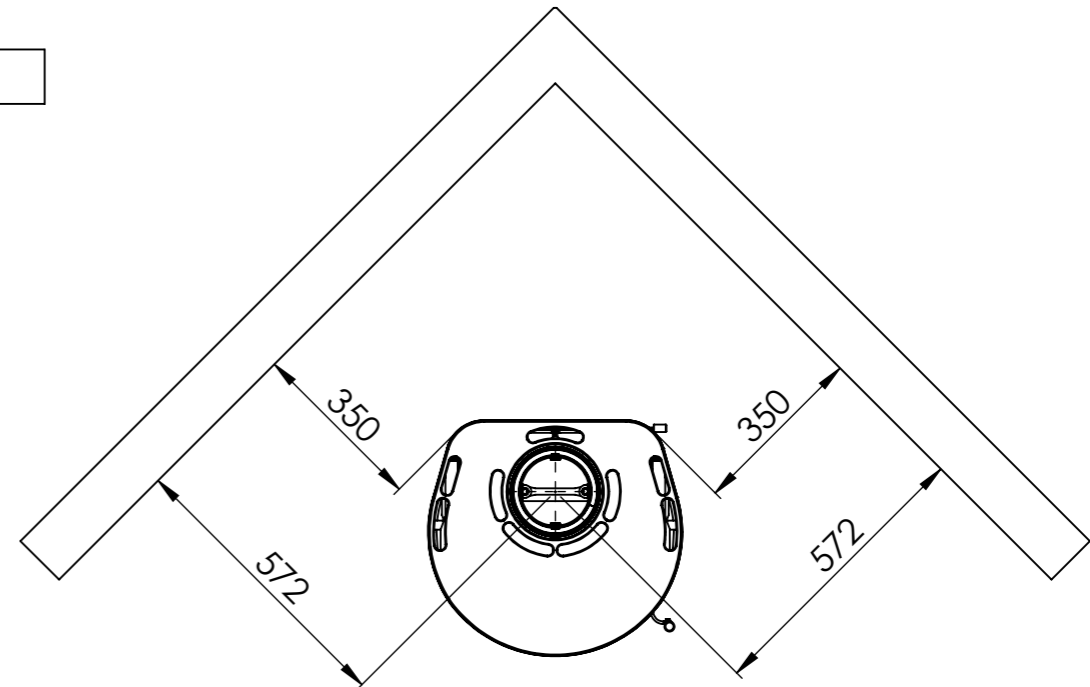

Serie	Scan-Line 500
Description	Scan-Line 590 Steel

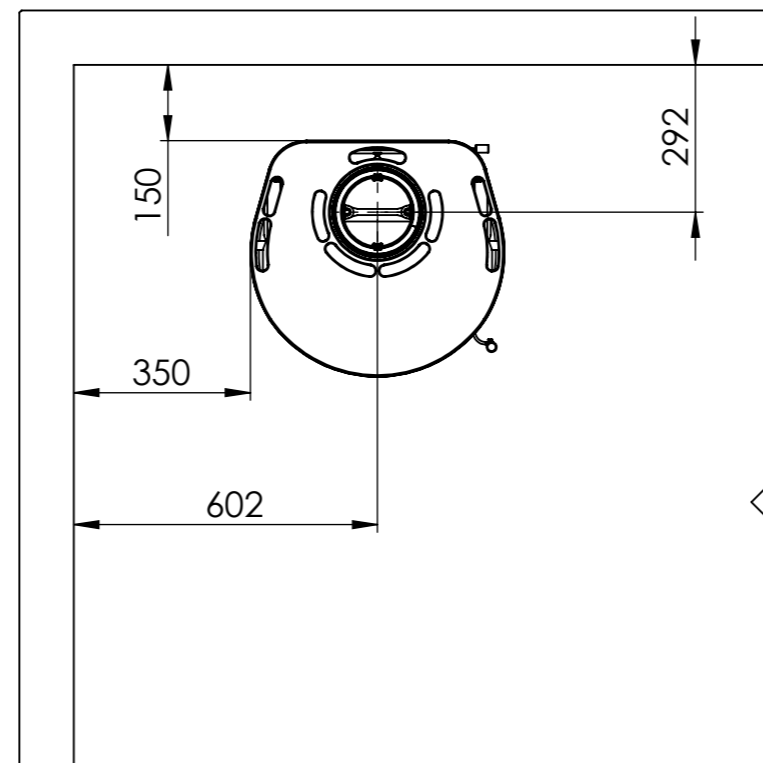
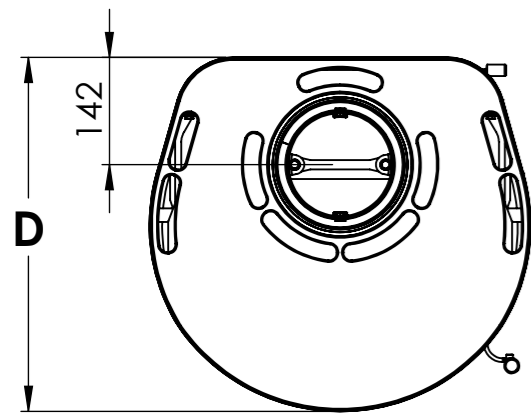
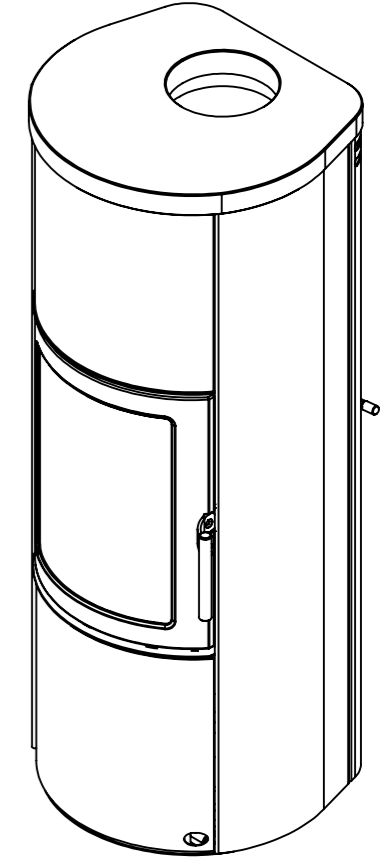
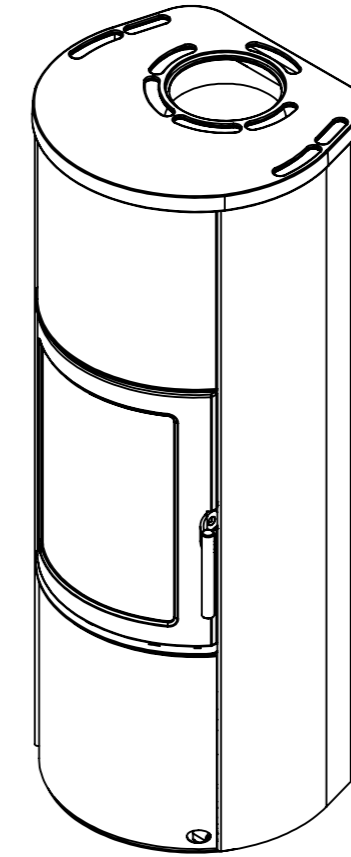
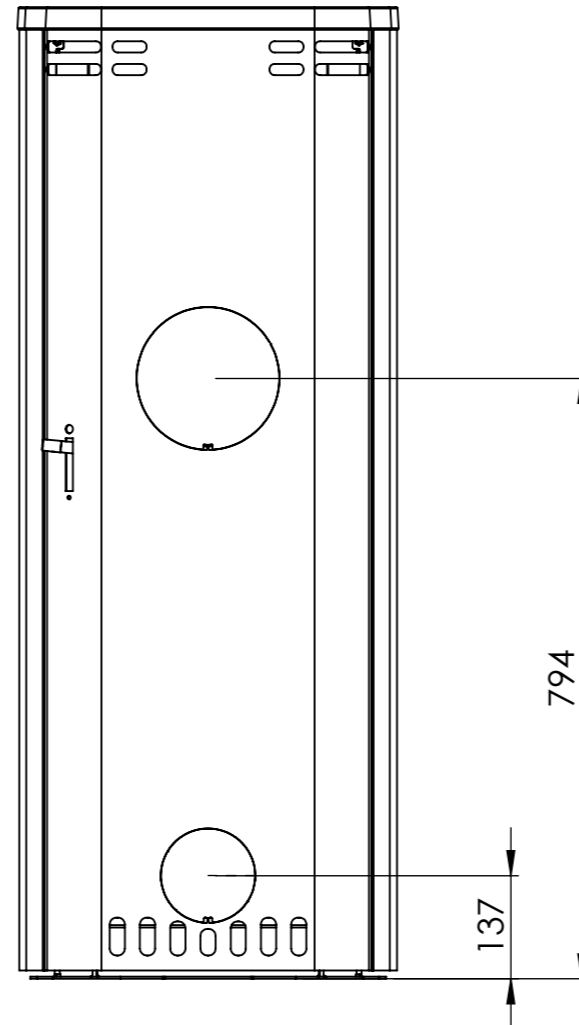
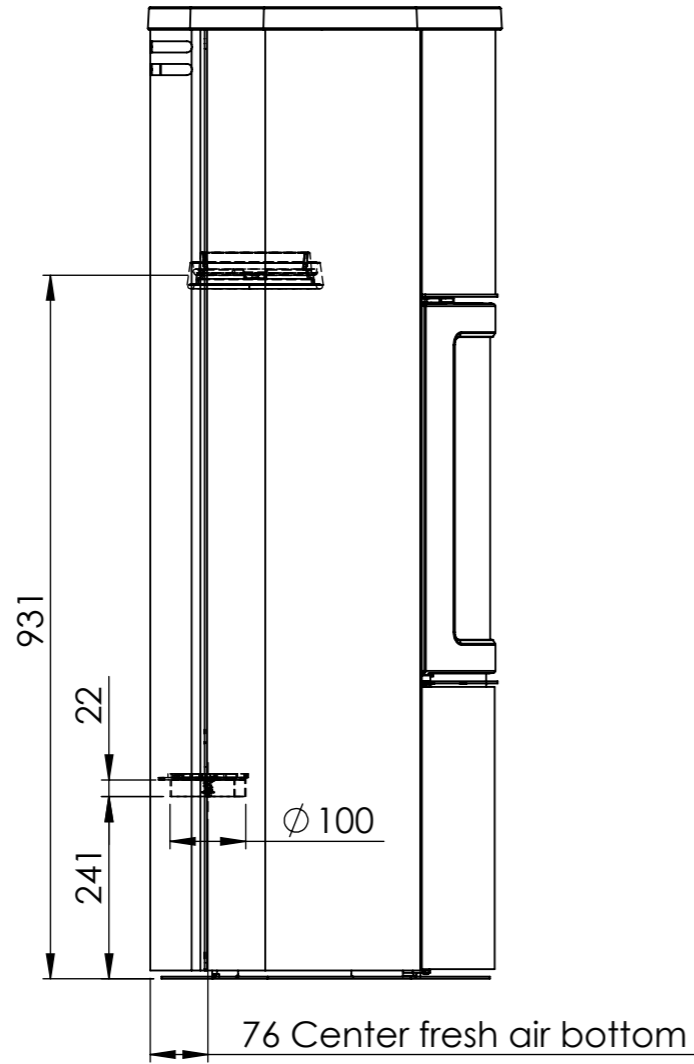
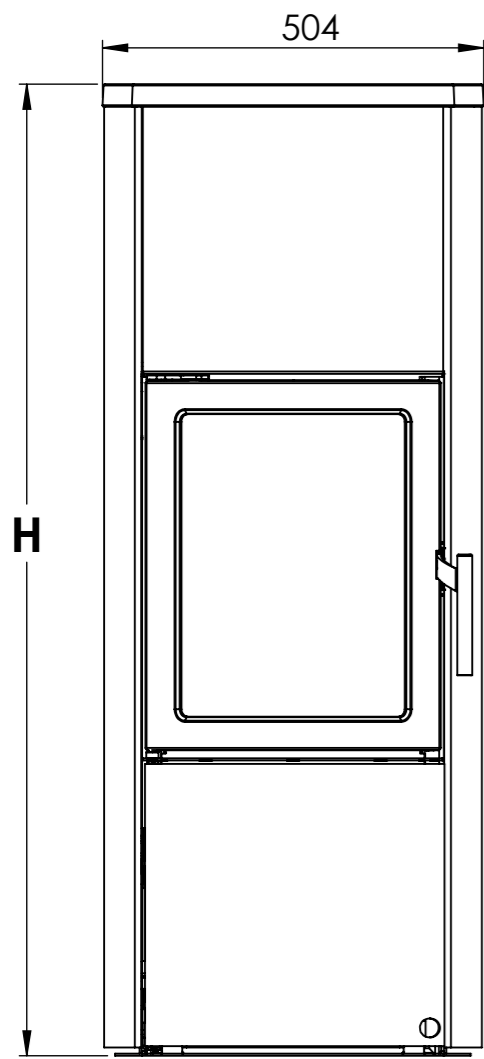

	Casted top	Stone top
D	468	469
H	1285	1295